





## ■ *Accessories for A004-9 models*

	Description	Part number	Suitable for
	<b>Protective sleeve</b>	1051.1569	SE 1051 A004-9 KE 1051 A004-9
 <i>New</i>	<b>Plug cap</b>	1051.1576	All SE, DS, DSR
 <i>New</i>	<b>Receptacle cap</b>	1051.1577	All KE, DKE, DKBE, DB
 <i>Soon obsolete</i>	<b>Plug cap</b>	1051.1570 Replaced by 1051.1576	SE 1051 A004-9
 <i>Soon obsolete</i>	<b>Cable receptacle cap</b>	1051.1571 Replaced by 1051.1577	KE 1051 A004-9

## ■ Combined sleeve and cap for A004-4 models

	Description	Part number	Suitable for
	Protective sleeve L1=122	1051.875	SE 1051 A004-4 1.4/6.6/12.6 SE 1051 A004-4T1895/13.6
	Protective sleeve L2=104	1051.874	SE 1051 A004-4 2.1Ls/10s/15.2
	Protective sleeve L1=140	1051.876	KE 1051 A004-4 1.4/6.6/12.6 KE 1051 A004-4T1895/13.6
	Protective sleeve L2=122	1051.877	KE 1051 A004-4 2.1Ls/10s/15.2

## ■ Caps for A004-3 and A004-4 models

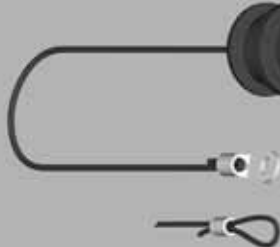
	Description	Part number	Suitable for
 <p><i>Soon obsolete</i></p>	Cap with fastener eyelet	1051.887 Replaced by 1051.1576	DS, DSR
 <p><i>Soon obsolete</i></p>	Cap with fastener eyelet	1051.897 Replaced by 1051.1577	DB, DKE
 <p><i>Soon obsolete</i></p>	Sealing cover in POM with O-ring and plastic coated stainless steel wire (Approx. length 400mm)	1051.816 Replaced by 1051.1576	SE, DS, DSR
 <p><i>Soon obsolete</i></p>	Sealing cover in POM with O-ring and plastic coated stainless steel wire (Approx. length 400mm)	1051.817 Replaced by 1051.1577	KE, DB, DKE

## ■ *Spanner for inner threaded ring*



Part number	Suitable for
TQ00.001	DKE+DSR 1051 A004-3 1.0/4.5/8.7+9.4 DKE+DSR 1051 A004-3 1.4/4.5/9.4 DKE+DSR 1051 A004-3 1.4/6.6/11.3
TQ00.002	SE+KE+DKE+DSR 1051 A004-4 1.4/6.6/12.6 SE+KE+DKE+DSR 1051 A004-4 T1895/13.6 SE+KE+DKE+DSR 1051 A004-4 2.1Ls/10s/15.2

## ■ *Hook spanner for slotted nuts*



Part number	Suitable for
TX00.105	Ø 30-32
TX00.106	Ø 34-36

## ■ *Nutdriver*



Part number	Suitable for
TQ00.005	Ø 31 DKBE 1051 A004-3+

## ■ *Shield crimp tool without dies*



Part number	Description
TX00.245	Daniels HX4 (M 22520/5-01)

## ■ *Shield crimp tool dies*



Part number	Hexagon width	Description
TX00.270	10.9	Daniels Y178 (M 22520/5-61)
TX00.271	13.51	Daniels Y151 (M 22520/5-27)

## ■ *Contact crimp tool*



Part number	Description
TX00.242	Buchanan 615708

## ■ *Contact crimp tool positioner*



Part number	Suitable for
TX00.315	All connectors corresponding to cable groups 1 to 4 <sup>1</sup>
TX00.317	All connectors corresponding to cable groups 5 to 6 <sup>1</sup>

<sup>1</sup> See list of recommended cables on page 23

## ■ Crimp ferrules

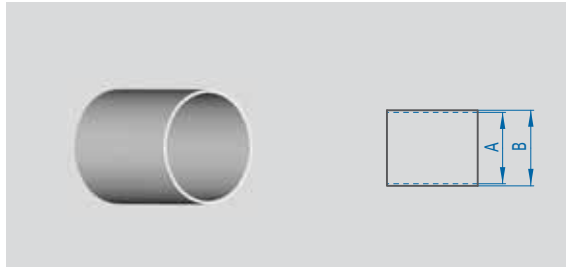

Part number	A	B	Suitable for
1051.910	11.8	12.5	SE 1051 A004-4T1895/13.6 KE 1051 A004-4T1895/13.6 DKE 1051 A004-4T1895/13.6 DSR 1051 A004-4T1895/13.6 DSR 1051 A004-4 2.1Ls/10s/15.2
1051.922	14.3	15.5	SE 1051 A004-4 2.1Ls/10s/15.2 KE 1051 A004-4 2.1Ls/10s/15.2 DKE 1051 A004-4 2.1Ls/10s/15.2

## ■ Solder lug with claws



Part number	D	Suitable for
1051.311	30	DB
1051.615	34	DS

## ■ Hexagon and slotted nuts

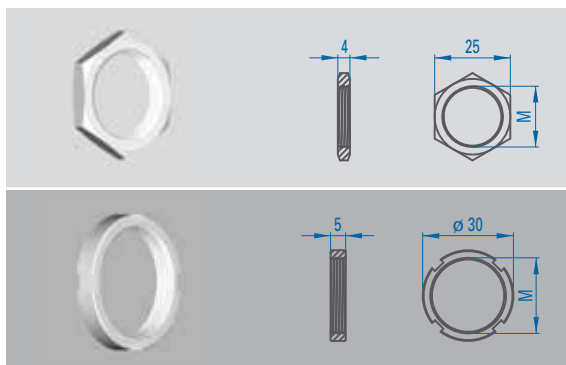

Part number	M	Suitable for
105.724	M20x1	DB
1051.611	M28x1	DS, DSR
105.865	M25x1	DKE 1051 A004-3
106.395	M30x1	DKE 1051 A004-4

## ■ Crimp and/or solder contacts

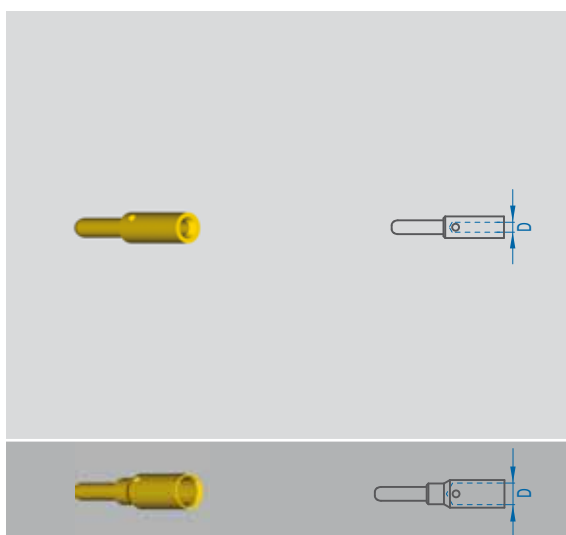

Part number	D	Suitable for
1051.900	1.0	All connectors corresponding to cable groups 1 and 2 <sup>1</sup> , except: SE 1051 A004-9 1.4/4.5/9.4 KE 1051 A004-9 1.4/4.5/9.4 DKE 1051 A004-3 1.4/4.5/9.4
1051.905	1.5	All connectors corresponding to cable groups 3 and 4 <sup>1</sup> , plus: SE 1051 A004-9 1.4/4.5/9.4 KE 1051 A004-9 1.4/4.5/9.4 DKE 1051 A004-3 1.4/4.5/9.4
1051.919	1.8	SE 1051 A004-HD Pro+ KE 1051 A004-HD Pro+
1051.906	2.5	All connectors corresponding to cable groups 5 and 6 <sup>1</sup>

<sup>1</sup> See list of recommended cables on page 23  
All dimensions shown are in millimeters and are for reference only.